

LAMELLE

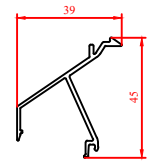

DWS Lamelle 30Z NP
P1184210

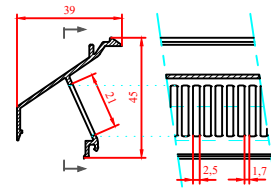

DWS Lamelle 30Z P1
T1184210

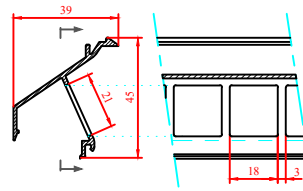

DWS Lamelle 30Z P2
T1184220

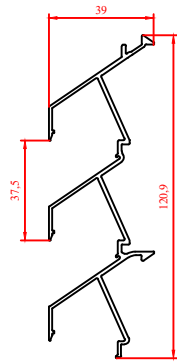

DWS Dreifachlamelle 30Z NP
P1177110

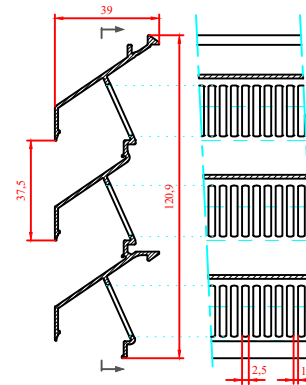

DWS Dreifachlamelle 30Z P1
T1177110

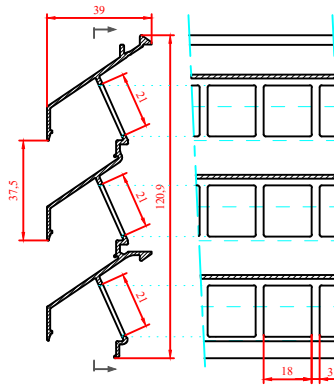

DWS Dreifachlamelle 30Z P2
T1177120

HALTEPROFIL

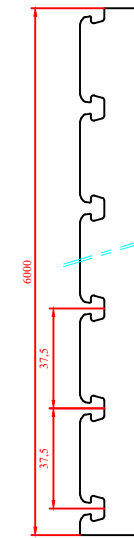

DWS Halteprofil 40/21
T1195010

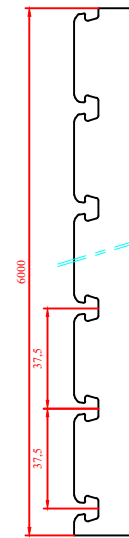

DWS Halteprofil 40/21 doppelt
T1540310

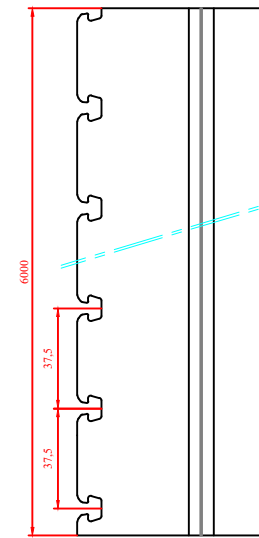

DWS Halteprofil 40/70 doppelt
T1540410

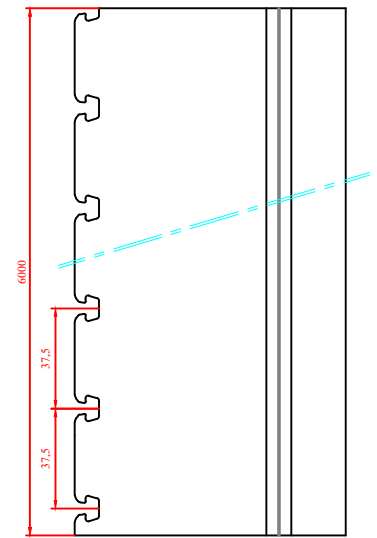

DWS Halteprofil 40/100 doppelt
T1900010

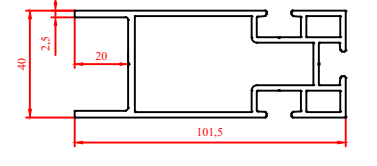
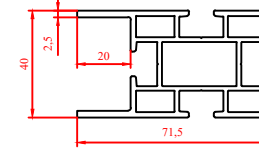
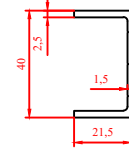
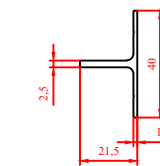

ECKPROFILE (1:2)

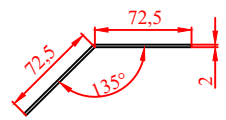

Eckprofil 72/72/135°
DWS 30Z + DWS 40/21
P1202810

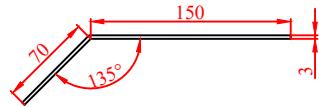

Eckprofil 70/150/135°
DWS 30Z + DWS 40/70
P1202710

EDELSTAHL GAZE

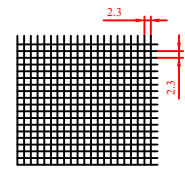

Edelstahl Insektengaze
2,3 x 2,3 mm
G0000800

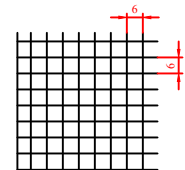

Edelstahl Vogelgaze
6 x 6 mm
G0000810

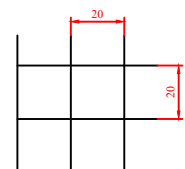

Edelstahl Vogelgaze
20 x 20 mm
G0000830

VERSCHIEDENE ALU TEILE

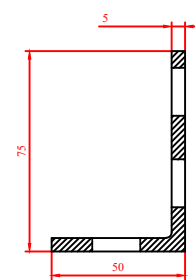

L - profil
75/50/5
T1121510

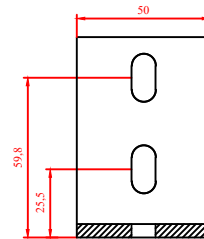

Unterlegscheibe
DIN9021 M8
G0000170



Unterlegscheibe
DIN125 M8
G0000174

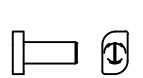

T-Bolz
M8
G0000150

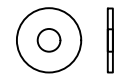

Sicherungsmutter
M8
G0000162



Rechteckmutter
M8
G0000182



Sechskantschraube mit
geschwinde bis Kopf
DIN 933 M8x70
G0000200



Sicherungsmutter
M8
G0000162

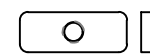

Rechteckmutter
M8
G0000182

VERSCHIEDENE TEILE

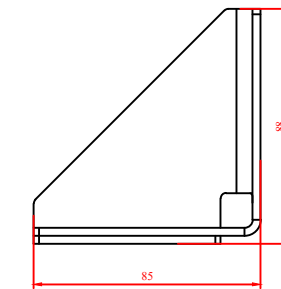

Verstärktes Edelstahl
L-Profil 85/85/3
G0105408

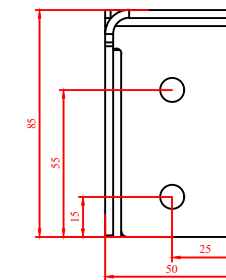
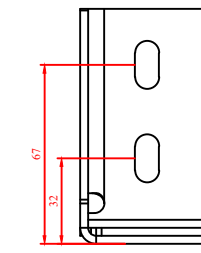

Einbruchhemmungsklasse 2 & 3

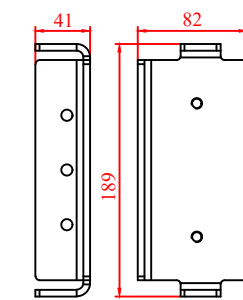

Einbruchhemmende Klaue
G0105202

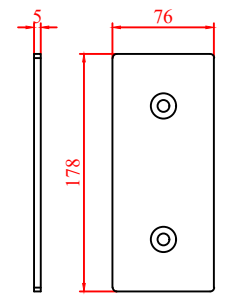

Abdeckplatte der Klaue
G0105201



Senkschraube
M8x40 mm
G0100674

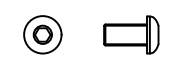

M8x16 Linsen-
Flanschkopfschraube
G0105091

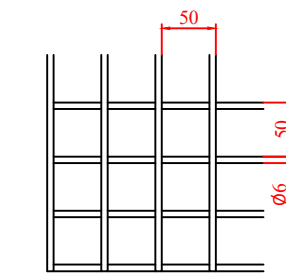

Galva Netze 1350x2750, Gewinde Ø
6mm, Maschenweite 50x50
G0105200